

HYBRID ENERGY SYSTEM FED ANFIS BASED SEPIC CONVERTER FOR DC LOADS

Rammukesh Narayanaswamy ¹, Mrs.S.P.G.Bhavani ²

^{1,2} Power Electronics and Drives, Meenakshi College of Engineering, Chennai, (India)

ABSTRACT

This Paper mainly deals with the implementation of Adaptive Neuro Fuzzy Inference System (ANFIS) in Pulse Width Modulation control of Single Ended Primary Inductor Converter (SEPIC). Generally PID, Fuzzy techniques are being used to control DC – DC converter. This paper presents a ANFIS controller based SEPIC converter for maximum power point tracking (MPPT) operation of a photovoltaic (PV) system. The ANFIS controller for the SEPIC MPPT scheme shows a high precision in current transition and keeps the voltage without any changes represented in small steady state error and small overshoot. The proposed scheme ensures optimal use of photovoltaic (PV) array, wind turbine and proves its efficacy in variable load conditions, unity and lagging power factor at the inverter output (load) side. The performance of the proposed ANFIS based MPPT operation of SEPIC converter is compared to those of the conventional PID and Fuzzy based SEPIC converter. The results show that the proposed ANFIS based MPPT scheme for SEPIC can transfer power to about 20 percent (approx) more than conventional system.

Keywords: ANFIS based MPPT control Fuzzy control, dc-dc power converters, photovoltaic cells, proportional-integral controller, and real-time system.

I. INTRODUCTION

Renewable Energy sources are gaining potential as conventional energy resources are minimum and pollution due to them are at alarming rates. Renewable energy technologies are suitable for off-grid services, serving the remote areas without having to build or extend expensive and complicated grid infrastructure. Therefore standalone system using renewable energy sources have become a preferred option. This paper is a review of hybrid renewable energy power generation systems focusing on energy sustainability. It highlights the research on the methodology, unit sizing, optimization, storage, energy management of renewable energy system.

The term hybrid power system is used to describe any power system combine two or more energy conversion devices, or two or more fuels for the same device, that when integrated, overcome limitations inherent in either [1]. The design and structure of a hybrid energy system obviously take into account the types of renewable energy sources available locally, and the consumption the system supports. Hybrid renewable energy systems have proven to be an excellent solution for providing electricity in future [2]. Considering the harness of solar energy, solar array comes into picture. Solar array needs to be optimized for tracking maximum power from solar rays. So there is a need for tracking technique. The optimization of power on PV is known as Maximum Power point tracking (MPPT). Studies on MPPT by comparing several methods such as hill climbing / P&O, incremental conductance, fractional open circuit voltage, short circuit fractional voltage, fuzzy logic control, the

current sweep, load voltage maximization, and dP/dI feedback control have been conducted [4]. In addition to these methods there are also other methods are used to maximize the PV MPPT using artificial intelligence such as PSO, ANFIS. In this case have been developed methods to maximize the power output of PV.

II. PROPOSED SYSTEM

This paper presents a new system configuration of the front-end rectifier stage for a hybrid wind/photovoltaic energy system. This configuration allows the two sources to supply the load separately or simultaneously depending on the availability of the energy sources. The inherent nature of this SEPIC fused boost converter, additional input filters are not necessary to filter out high frequency harmonics. Harmonic content is detrimental for the generator lifespan, heating issues, and efficiency. The fused multi input rectifier stage also allows Maximum Power Point Tracking (MPPT) to be used to extract maximum power from the wind and sun when it is available. An adaptive MPPT algorithm will be used for the wind system and a standard perturb and observe method will be used for the PV system. Operational analysis of the proposed system will be discussed in this paper. Simulation results are given to highlight the merits of the proposed circuit. When a source is insufficient in meeting the load demands, the other energy source can compensate for the difference. For the continuous supply to be provided, we consider a SEPIC converter which is known for its fast switching characteristics. For switching the IGBT switches PWM controllers are implemented which are in turn controlled by ANFIS based controller.

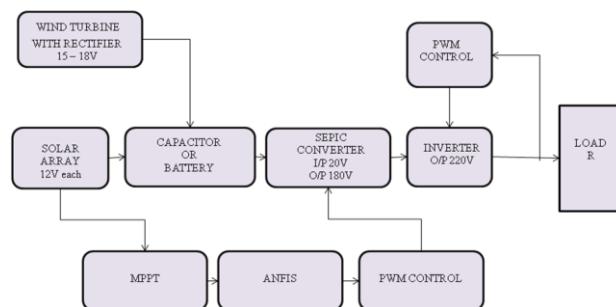

Fig 1: Proposed HES fed SEPIC converter.

III. MODELLING PV ARRAY

PV array is formed by arranging PV cells in both series and parallel combinations to get particular output voltage and current. The output power of the PV modules is affected by light radiation and temperature [9]. A long with the increase of light radiation, the greater the output power can be generated by the PV module and vice versa. In this paper a single 12V solar cell is used for simulating purpose.

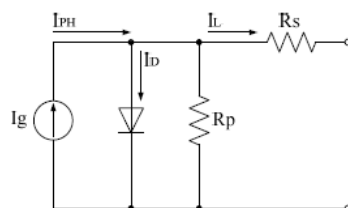

Fig 2: Equivalent circuit of a PV cell.

$$I_L = I_{PH} - I_S \left[\exp\left(\frac{qV_d}{AK_B T}\right) - 1 \right] - \frac{V_d}{R_{SH}} \quad (1)$$

$$I_{PH} = \left[I_{SC} + K_1 (T_C - T_{Ref}) \right] G \quad (2)$$

$$I_S = I_{RS} \left(\frac{T_C}{T_{Ref}} \right)^3 \exp \left[qE_B \left(\frac{1}{T_{Ref}} - \frac{1}{T_C} \right) / K_B A \right] \quad (3)$$

$$I_{RS} = \frac{I_{SC}}{\left[\exp\left(\frac{qV_{OC}}{N_S K A T_C}\right) - 1 \right]} \quad (4)$$

$$I_L = N_P I_{PH} - N_P I_S \left[\exp(qV/N_S K T_C A) - 1 \right] \quad (5)$$

Where, I_{PH} = photo - current

I_L = current at the output terminal

I_S = saturation current of the diode

I_{RS} = reverse saturation current

T_C = cell working temperature

T_{Ref} = reference temperature

R_S = series resistance

K_B = Boltzman constant

V_d = diode voltage

G = solar insolation

q = electron charge

S.NO	Parameters	Specification
1.	Output Voltage From Single Panel	12V
2.	Total Number Of Solar Cell Used	12
3.	Total Number Of Solar Cell In Single String	4
4.	Number Of Strings In Single Panel	3
Rating Of The Entire Solar System Used In The Project		
5.	OPEN CIRCUIT VOLTAGE V_{oc}	12V
6.	SHORT CIRCUIT CURRENT I_{sc}	12A
7.	Irradiance	1000Wb/m ²
8.	Power	140 Watts

Table 1: PV cell simulation parameters.

IV. MODELLING OF WIND TURBINE

Double Fed Induction Generator is used as wind turbine for this simulink model [10]. Due to supply to the slip of induction machine, control over generation is easy.

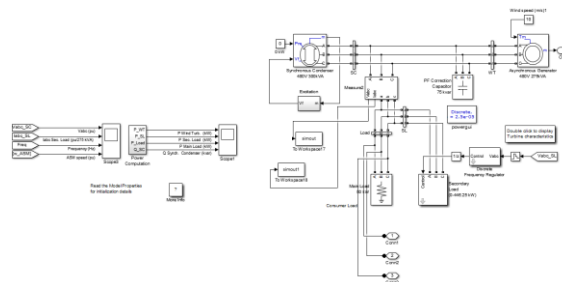

Fig 3: Wind turbine model for simulink.

SEPIC converter is the development of a buck-boost converter with the same function that raising and lowering the voltage [9]. It gives non-inverted output and output voltage is controlled by switching single MOSFET switch.

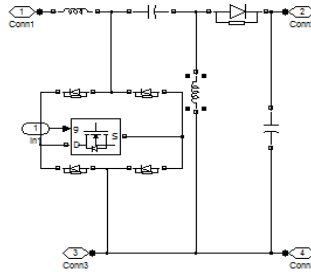

Fig 4: SEPIC modeling.

$$V_o = V_{IN} \frac{D}{1 - D} \tag{6}$$

$$L_1 = \frac{V_{IN} \times D}{\Delta i_{L1} \times f_s} \tag{7}$$

$$L_2 = \frac{V_{IN} \times D}{\Delta i_{L2} \times f_s} \tag{8}$$

$$C_o = \frac{D}{R \times \frac{\Delta V_{C_o}}{V_o} \times f_s} \tag{9}$$

VI. ANFIS AND MPPT MODELLING

ANFIS is a controller that combines the advantages possessed by the fuzzy controller and neural network. It is said to be the successor of both neural and fuzzy controller [8]. The ANFIS controller outputs the crisp value of maximum available power from the Solar PV module corresponding to specific temperature and solar irradiance conditions. Maximum power point trackers (MPPTs) play an important role in photovoltaic (PV) power systems because they maximize the power output from a PV system for a given set of conditions, and therefore maximize the array efficiency [14]. Thus, an MPPT can minimize the overall system cost. Considering the MPPT, perturb and observe method is used as MPPT technique.

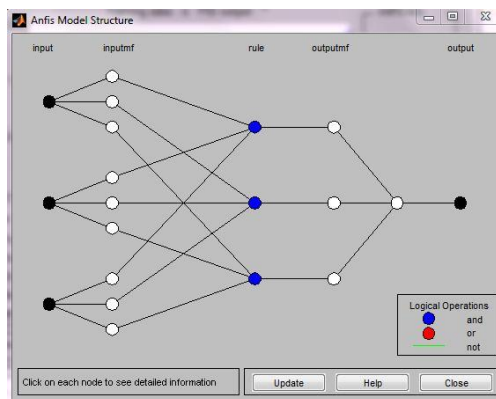

Fig 5: ANFIS structure.

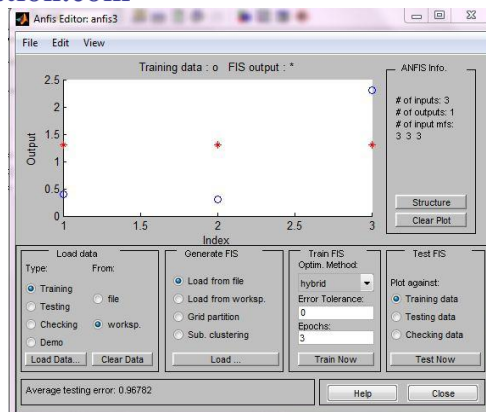

Fig 6: ANFIS editor.

The ANFIS algorithm is an adaptive network which has a similar training scheme to the neural network whilst offering equivalent performance to a fuzzy logic inference system. Although the ANFIS algorithm is a computationally complex algorithm to implement [7], the advancement of fast and affordable processing. Sugeno method is used to create ANFIS structure in this simulink model.

VII. SIMULATION RESULTS

MATLAB simulink model is as below.

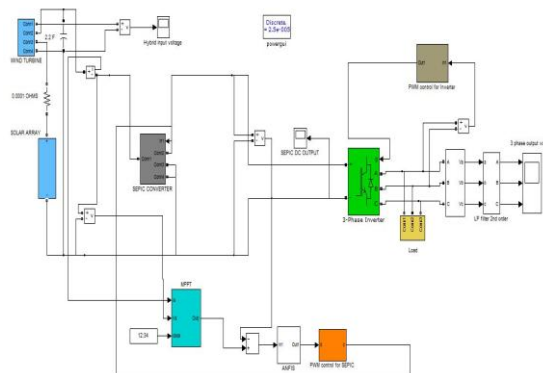

Fig 7: Simulink model.

Simulation parameters and their respective values are stated as below.

SIMULATION PARAMETERS	VALUES
SOLAR ARRAY PARAMETERS	
Generation voltage	180 V
Resistance	10 Ohms
Capacitance	2.2 micro Farad
WIND TURBINE PARAMETERS	
Generation voltage	180 V
Capacitance	2.2 micro Farad
DIODE RECTIFIER	
Resistance	10 Ohms
Forward voltage	0.8 V

Snubber resistance	500 Ohms
Snubber Capacitance	250 nano Farad
SEPIC CONVERTER	
Inductance (L_1 & L_2)	3 milli Henry
Capacitance (C_1 & C_2)	2.22 nano Farad
MOSFET (SEPIC)	
Resistance	2 Ohms
Internal diode Resistance	0.01 Ohms
Snubber Resistance	1×10^5 Ohms
Snubber Capacitance	infinity

Output voltage of SEPIC converter can be boosted according to the control of PWM signals. SEPIC output voltage is boosted to 220V. Then the inverter is used to invert the DC to AC (if required). Both DC and AC output waveforms are shown below.

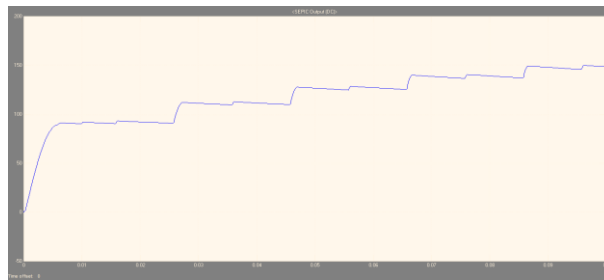

Fig 8: SEPIC DC output voltage.

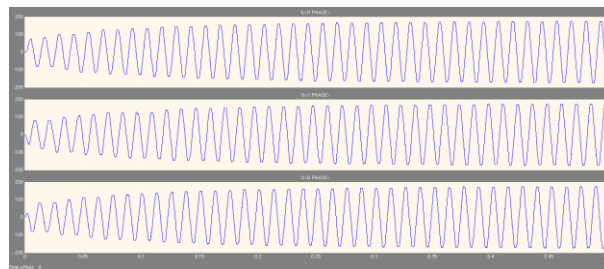

Fig 9: 3 phase inverter output for an R load.

VIII. CONCLUSION

This dissertation is on modelling of a hybrid wind/PV alternative energy system and connecting to HVDC grid using a DC –DC converter which is controlled using ANFIS controller. The main part of the dissertation focuses on modelling different energy systems and the corresponding control scheme development. Special emphasis is put on the modelling ANFIS control of SEPIC converter based Hybrid system. The future work will be to model the proposed hybrid system using ANFIS combined with Genetic algorithm, and to design the proposed hybrid system and implement in hardware. Also, the system has to be extended to higher ratings and solve for the synchronization issues.

REFERENCES

- [1] "HYBRID SYSTEM OF PV SOLAR / WIND & FUEL CELL", International Journal of Advanced Research in Electrical, Electronics and Instrumentation Engineering, vol. 2, no. 8, p. 14, 2013.
- [2] K. Strunz, E. Abbasi and D. Huu, "DC Microgrid for Wind and Solar Power Integration", IEEE Journal of Emerging and Selected Topics in Power Electronics, vol. 2, no. 1, pp. 115-126, 2014.
- [3] El Khateb, N. Rahim, J. Selvaraj and M. Uddin, "Fuzzy-Logic-Controller-Based SEPIC Converter for Maximum Power Point Tracking", IEEE Transactions on Industry Applications, vol. 50, no. 4, pp. 2349-2358, 2014.
- [4] D. Hohm and M. Ropp, "Comparative study of maximum power point tracking algorithms", Prog. Photovolt: Res. Appl., vol. 11, no. 1, pp. 47-62, 2002.
- [5] Implementation and control of Multi Input Power Converter for Grid Connected Hybrid Renewable Energy Generation System", Student Pulse Academic Journal, vol. 3, no. 6, p. 7, 2011.
- [6] Ajami, H. Ardi and A. Farakhor, "A Novel High Step-up DC/DC Converter Based on Integrating Coupled Inductor and Switched-Capacitor Techniques for Renewable Energy Applications", IEEE Transactions on Power Electronics, vol. 30, no. 8, pp. 4255-4263, 2015.
- [7] "An ANFIS-PI Based Boost Converter Control Scheme", 2015.
- [8] H. Abu-Rub, A. Iqbal and S. Ahmed, "Adaptive neuro-fuzzy Inference system-based maximum power point tracking of solar PV modules for fast varying solar radiations", International Journal of Sustainable Energy, vol. 31, no. 6, pp. 383-398, 2012.
- [9] "Modeling and Analysis of an Integrated PV Array and SEPIC Converter", International Conference on Control, Instrumentation, Communication and Computational Technologies (ICCICCT), vol. 2, no. 14, p. 5, 2014.
- [10] H. Ko, G. Yoon, N. Kyung and W. Hong, "Modeling and control of DFIG-based variable-speed wind-turbine", Electric Power Systems Research, vol. 78, no. 11, pp. 1841-1849, 2008.
- [11] S. Yang, Y. Wu, H. Lin and W. Lee, "Integrated Mechanical and Electrical DFIG Wind Turbine Model Development", IEEE Transactions on Industry Applications, vol. 50, no. 3, pp. 2090-2102, 2014.
- [12] T. Esram and P. Chapman, "Comparison of Photovoltaic Array Maximum Power Point Tracking Techniques", IEEE Transactions on Energy Conversion, vol. 22, no. 2, pp. 439-449, 2007.
- [13] H. Renaudineau, F. Donatantonio, J. Fontchastagner, G. Petrone, G. Spagnuolo, J. Martin and S. Pierfederici, "A PSO-Based Global MPPT Technique for Distributed PV Power Generation", IEEE Trans. Ind. Electron., vol. 62, no. 2, pp. 1047-1058, 2015.
- [14] H. Abu-Rub, A. Iqbal and S. Ahmed, "Adaptive neuro-fuzzy inference system-based maximum power point tracking of solar PV modules for fast varying solar radiations", International Journal of Sustainable Energy, vol. 31, no. 6, pp. 383-398, 2012.
- [15] Non conventional energy source. Tata Mc Graw Hills, 2006.